

B 220kV

%

%%

\$")

%&

\$")

6

%'

% | . . . | 100% 5%)\$<nw)!

% (

&) \$

%)

%

%*

&) aa⁸

% +

\$")

%,

% -

7JH

7JH

; =G

DH

%%\$

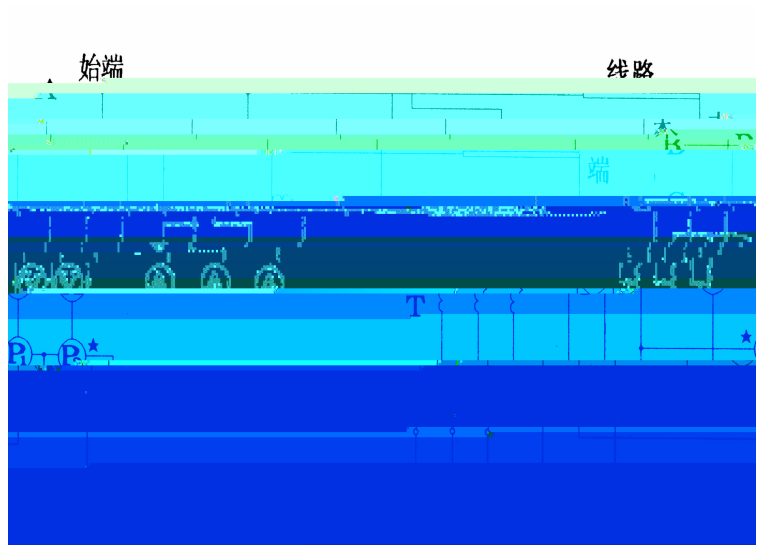

&

&" %

6%

$$\frac{\quad}{3}$$

$$\frac{\quad}{3}$$

$\frac{1}{2}$ fl t

6%

$$1 \frac{1}{3^2} \quad \text{fl} \quad \# \quad t$$

$$1 \sqrt{3} \quad \text{fl} \quad \# \quad t$$

$$1 \sqrt{\frac{2}{1} \frac{2}{1}} \quad \text{fl} \quad \# \quad t$$

⊗

⊗

&\$\$

\$" \$-Z^{" (# #

\$" \$*Z^{" ' # #

\$" \$' Z^{" & # #

$$1 \frac{1}{1} \quad +\$V \quad ,)V$$

&" &

6& .

&\$\$

U

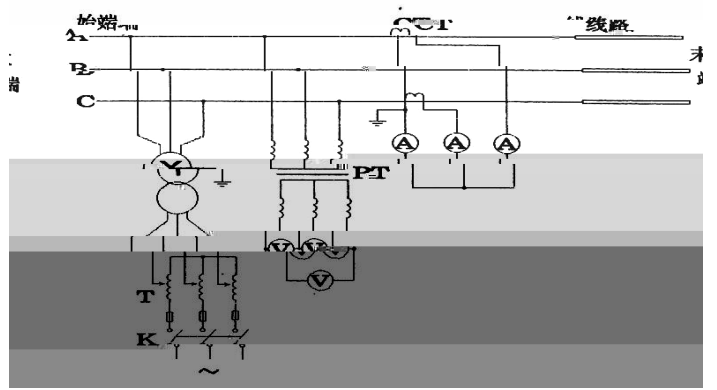

&" (

6(.

0 $\frac{0}{3}$

0 0

0 $\frac{0}{2} 10^{12}$

#

* %\$

M1 \$" *

\$", LM

M2M

&")

6)

\$.

* $\hat{A} \hat{A} \hat{A} \hat{A}$

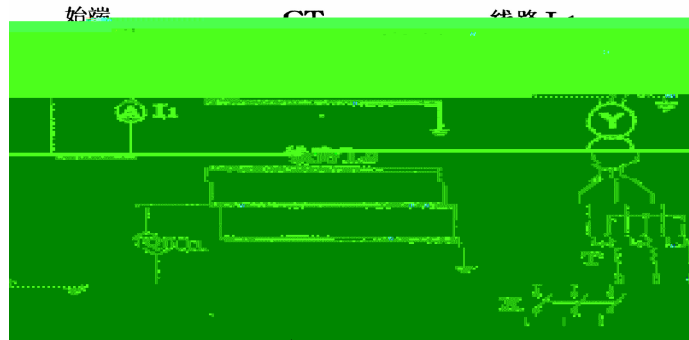

6)

,)\$\$ # fl 7

3.4

B9

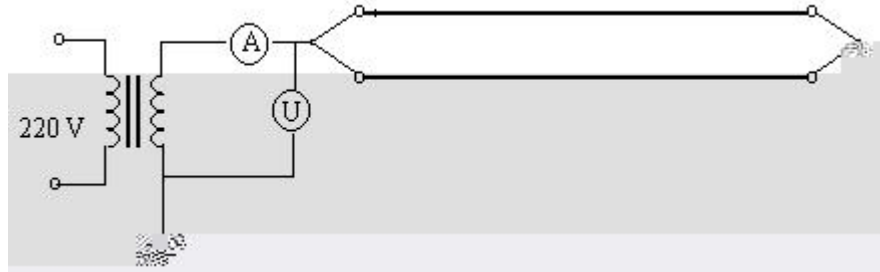

B9

$$0 \frac{y}{2} \%^{12}$$

* %\$

\$" * \$" , 7 1

3.5

B10

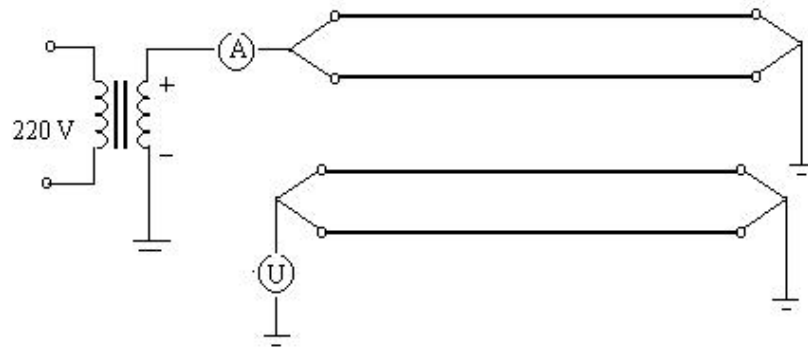

B10

$$\frac{2}{0}$$

/

0 0

/

300

\$" (! \$" * 0 fl 0

7

(

(" %

40Hz

60Hz

4.2

("'

("' "%

\$" &) » &) \$»

w &

("' " &

\$" \$) Ç : %Ç :

w &

("' "'

\$" %w ' * \$v

w &

("' "(

(\$5

&5

(" (

(")

(" *

(" * "%

(" * " &

(" * "'

(" * " (

)

)" %

)" &

&) |

f| %\$\$i

U

V

%\$\$i

W

X"

% &

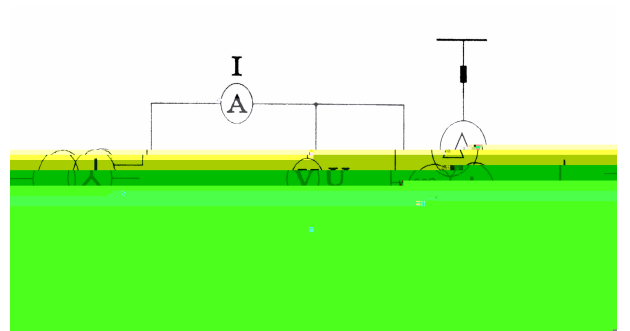

6%%M#M# M# #M M# #

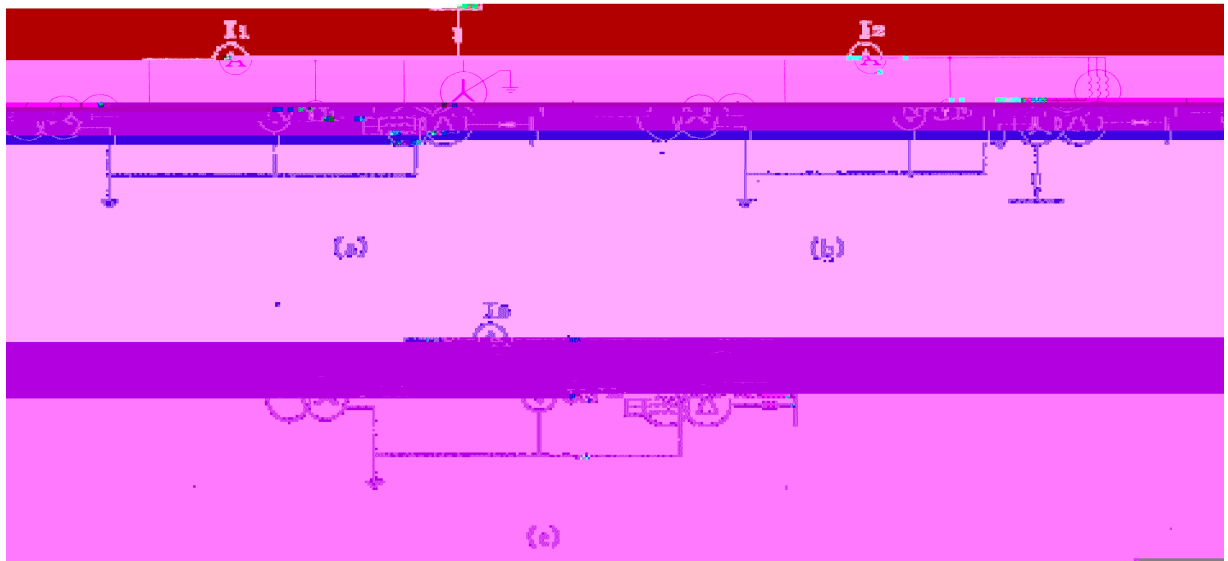

6% $M_{\#}N_{\#}$

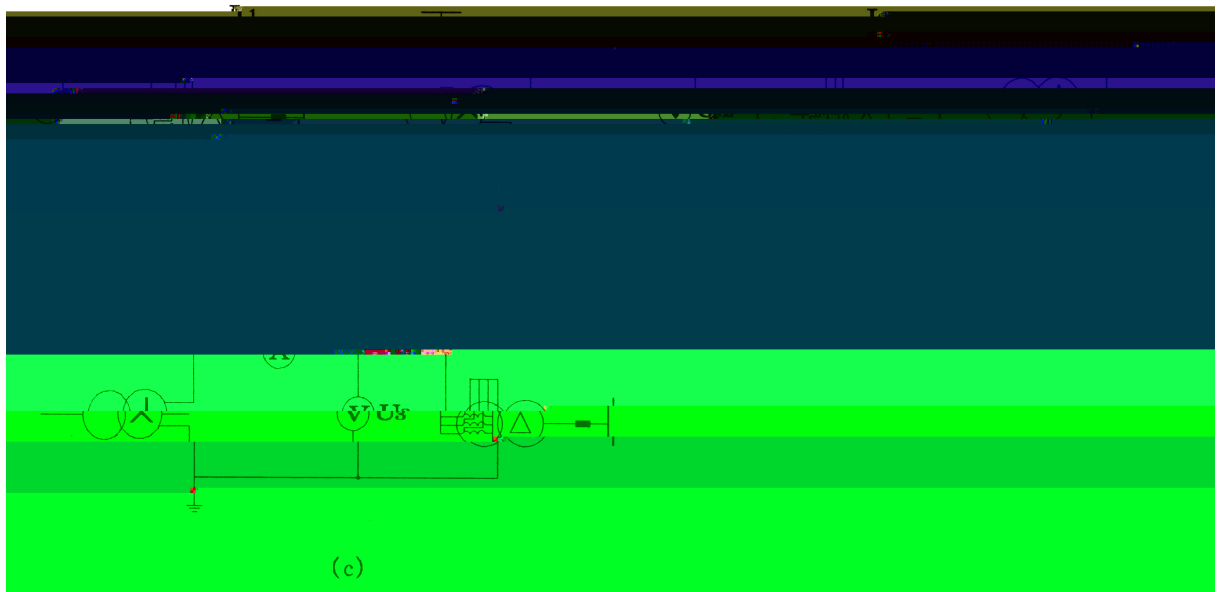

6% $M_{\#}N_{\#}$

fl V

$X_{1,2,3}$

W

$X_{\%}$

flU

$X_{\&}$

!

